

Quick Reference MDrive® 17 Hybrid Motion Control



Notes and Warnings

Installation, configuration and maintenance must be carried out by qualified technicians only. You must have detailed information to be able to carry out this work. This information can be found in the user manuals.

- Unexpected dangers may be encountered when working with this product!
- Incorrect use may destroy this product and connected components!

The user manuals are not included, but may be obtained from the Internet at: <http://www.imshome.com/downloads/manuals.html>.

Required for Setup*

- PC running Microsoft® Windows XP Service Pack 2 or greater.
- IMS Terminal integrated program editor and terminal emulator (available online).
- +12 to +48 VDC unregulated linear or switching power supply.
- RS-422/485 communications interface (recommended: MD-CC402-001 communication converter).

You may also need:

- Power interface to 2-pin wire crimp connector (recommended: PD02-2300-FL3 prototype development cable).
- I/O interface to 14-pin wire crimp connector (recommended: PD14-2334-FL3 prototype development cable).

* If you purchased your MDrive Hybrid with a QuickStart Kit, you have received all of the connecting cables needed for initial functional setup and system testing.

Getting Started

All documentation, software and resources are available online at: http://www.imshome.com/products/mdrive_motor_driver.html.

Connecting Power and I/O

Please refer to the opposite side of this document for connecting details and available connectivity options including prototype development cables and mating connector kits.

Connecting Communications — RS-422/485

1. Connect RS-422/485 communication converter to MDrive Hybrid and PC.
2. Install the communication converter drivers onto PC (available online).
3. Install and open IMS Terminal.
4. Apply power to the device.
5. Within IMS Terminal, click into the Terminal Window (shown below).
6. Key in CTRL+C. The sign-on message: "Copyright 2001-2010 by Schneider Electric Motion USA" should appear, verifying that communications is active.

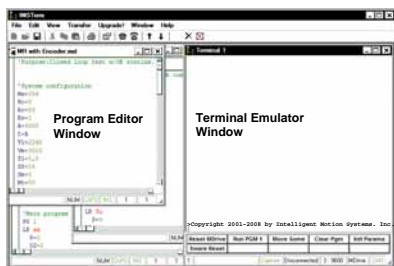

General Specifications

Electrical Specifications	
Input Voltage (+V) Range*	+12 to +48 VDC
Max Power Supply Current (Per MDrive)*	2 A
Aux-Logic Input Voltage**	+12 to +24 VDC
Aux-Logic Input Current**	194 mA Max

*Actual Power Supply Current will depend on voltage and load.
**Used to power logic circuitry in the absence of +V.

Environmental Specifications	
Operating Temperature (non-condensing)	Heat Sink: -40°C to +85°C Motor: -40°C to +100°C

I/O Specifications	
General Purpose I/O - Number and Type	
I/O Points 1-4	4 I/O programmable as inputs or outputs (sinking or sourcing)
General Purpose I/O - Electrical	
Inputs	TTL up to +24 VDC
Sinking Outputs	Up to +24 VDC
Sourcing Outputs	+12 to +24 VDC
Output Sink Current	up to 600 mA (One Channel in each I/O Bank)
Logic Threshold (Logic 0)	< 0.8 VDC
Logic Threshold (Logic 1)	> 2.2 VDC
Protection (Sinking)	Over Temp, Short Circuit
Protection (Sourcing)	Transient, Over Voltage, Inductive Clamp
Analog Input	
Resolution	10 Bit
Range (Voltage Mode)	0 to +5 VDC, 0 to +10 VDC
Range (Current Mode)	4 to 20 mA, 0 to 20mA
Trip Output/Capture Input	
Logic Threshold	+5V TTL Input, TTL Output (with 2 kΩ Load to Ground)

Communications Specifications	
Protocol	RS-422/RS-485
BAUD Rate	4.8k, 9.6k, 19.2k, 38.4k, 115.2 kbps

Motion Specifications	
Microstep Resolution - Open Loop	
Number of Resolutions	20

Available Microsteps Per Revolution									
200	400	800	1000	1600	2000	3200	5000	6400	10000
12800	20000	25000	25600	40000	50000	51200	36000 ¹	21600 ²	25400 ³

1=0.01 deg/μstep 2=1 arc minute/μstep 3=0.001 mm/μstep

Software Specifications	
Program Storage Type/Size	Flash/6384 Bytes
User Program Labels and Variables	192
Party Mode Addresses	62

Mechanical Specifications

Dimensions in inches (mm)

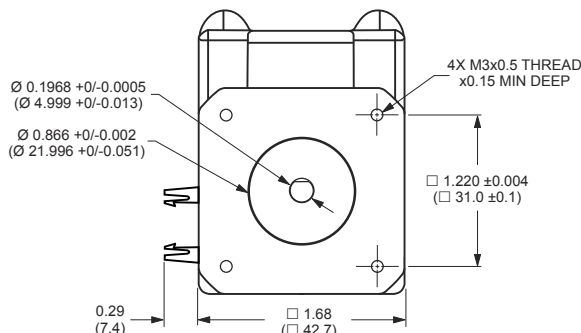
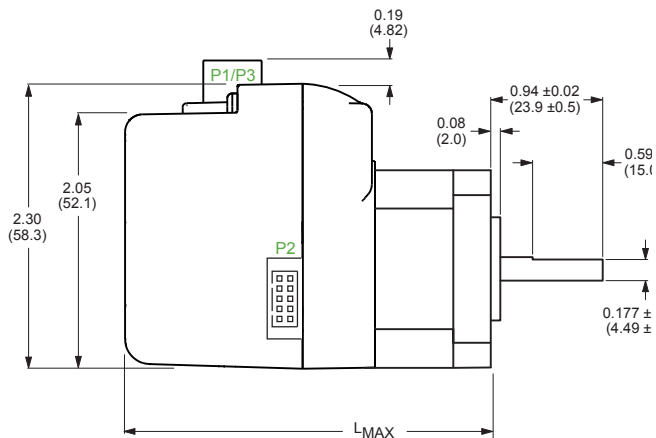

Motor stack length	L _{MAX}
Single	3.01 (76.45)
Double	3.25 (82.55)
Triple	3.65 (92.71)

MDrive Hybrid 17 Motion Control Connectivity Options

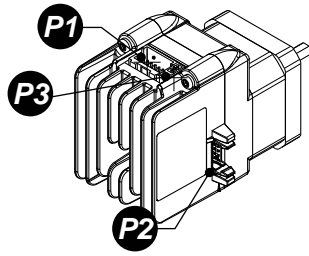

Connector Style Function

- P1** 14-pin Wire Crimp..... I/O
- P2** 10-pin Wire Crimp..... Communications
- P3** 2-pin Wire Crimp..... Power

P1 I/O

14-pin wire crimp

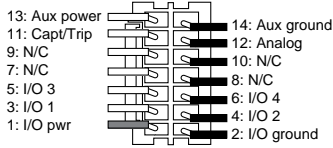

Prototype Development Cable p/n: PD14-2334-FL3

Speed test and development with pre-wired mating connector.

To MDrive
14-pin wire crimp
JST connector

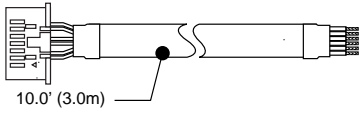

To I/O

Pin #	Wire Colors	Function
Pair 13	White	Aux Power
Pair 14	Black	Aux Ground
Pair 11	Green	Capt/Trip
Pair 12	Black	Analog In
Pair 9	Blue	No connect
Pair 10	Black	No connect
Pair 7	Yellow	No connect
Pair 8	Black	No connect
Pair 5	Brown	I/O3
Pair 6	Black	I/O4
Pair 3	Orange	I/O1
Pair 4	Black	I/O2
Pair 1	Red	I/O Power
Pair 2	Black	I/O Ground

Mating Connector Kit p/n: CK-09

Use to make your own cables, kit contains 5 mating connector shells with crimp pins. JST crimp tool recommended.

JST Parts Shell: PADP-14V-1-S
Pins: SPH-001T-P0.5L

P3 Power

2-pin wire crimp

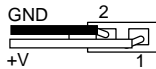

Prototype Development Cable p/n: PD02-2300-FL3

Function: Power Interface

To MDrive
2-pin wire crimp



To Power

Pin #	Wire Colors	Function
2	Black	Power Ground
1	Red	+V

Mating Connector Kit p/n: CK-04

Use to make your own cables, kit contains 5 mating connector shells with crimp pins. Tyco crimp tool recommended.

Tyco Parts Shell: 794617-2
Pins: 794610-1

P2 Communications — RS-422/485

10-pin wire crimp

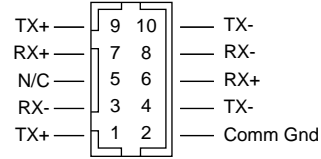

Communications Converter p/n: MD-CC402-001

Electrically isolated in-line USB to RS-422/485 converter pre-wired with mating connector to conveniently program and set configuration parameters.

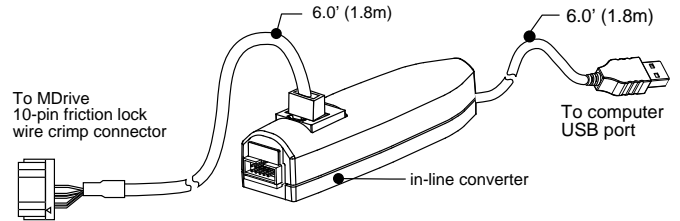

Prototype Development Cable p/n: PD10-1434-FL3

Speed test and development with pre-wired mating connector. Recommended for multi-drop systems, can be used in conjunction with the MD-CC402-001.

To MDrive
10-pin friction lock
wire crimp connector

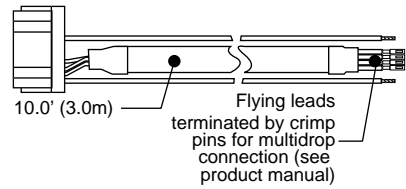

To Communications

Pin #	Wire Colors	Function
5	White/Red Stripe	N/C
1	White/Blue Stripe	TX+
4	Blue/White Stripe	TX-
6	White/Orange Stripe	RX+
3	Orange/White Stripe	RX-
2	Green/White Stripe	GND

Mating Connector Kit p/n: CK-02

Use to make your own cables, kit contains 5 mating connector shells with crimp pins. Hirose crimp tool recommended.

Hirose Parts Shell: DF11-10DS-2C
Pins: DF11-2428SC