

NEMA34 stepper motors

1.8° 2-phase stepper motors



Dimensions — NEMA34

Dimensions in inches (mm)

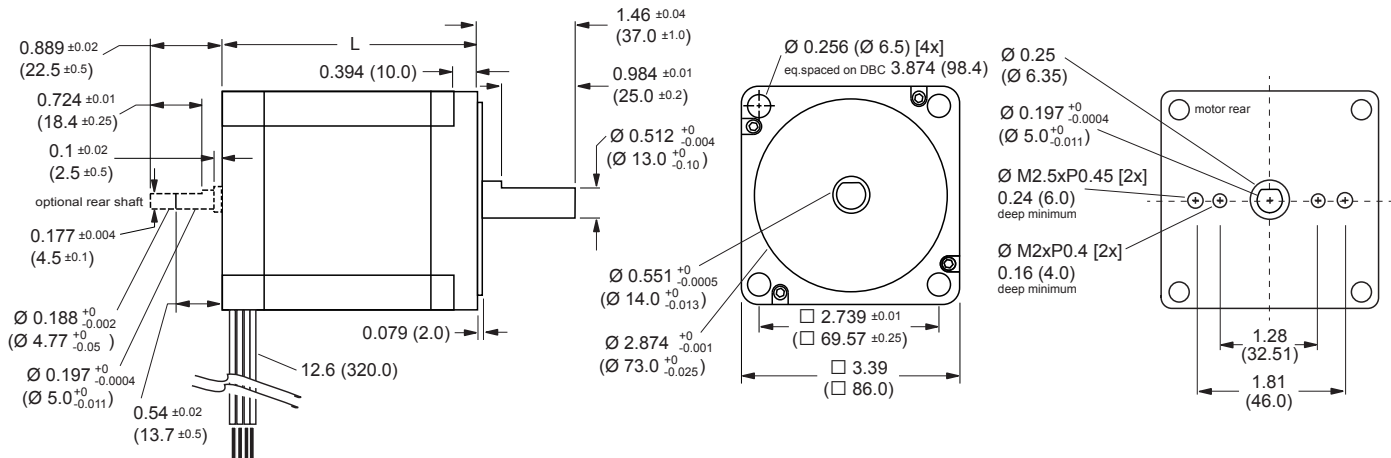

	L
M-3424-6.3•	2.48 (63)
M-3431-6.3•	3.15 (80)
M-3447-6.3•	4.72 (120)

Ambient conditions

Ambient temperature	°C	-25 ... +40
Max. installation height over m.s.l. without power loss	m	< 1000
Transport and storage temperature	°C	-25 ... +70
Relative humidity	%	15 ... 85, no condensation allowed
Thermal class		130 (B)

Electrical and mechanical data

NEMA34	part #	M-3424-6.3•	M-3431-6.3•	M-3447-6.3•
Stack length		single	double	triple
Phase current	amps	6.3	6.3	6.3
Holding torque	oz-in	408	574	1090
	N-cm	288	405	770
Rotor inertia	oz-in-sec ²	0.01275	0.01924	0.03849
	kg-cm ²	0.90	1.35	2.70
Phase inductance	mH	1.9	3.3	6.2
Phase resistance	Ω	0.30	0.32	0.56
Weight	oz	60.0	84.7	141.1
	grams	1700	2400	4000

References

Example:	M - 3 4 2 4 - 6.3 S
Motor type M = stepper motor	M - 3 4 2 4 - 6.3 S
Flange size 34 = NEMA34 (85 mm)	M - 3 4 2 4 - 6.3 S
Motor length 24 = single stack 31 = double stack 47 = triple stack	M - 3 4 2 4 - 6.3 S
Phase current 6.3 = 6.3 amp	M - 3 4 2 4 - 6.3 S
Shaft S = single shaft D = double shaft	S
Optional encoder Selecting the encoder option replaces the shaft designator in the part number ES = single-end optical encoder ED = differential optical encoder 100 = line count 200 = line count 250 = line count 400 = line count 500 = line count 1000 = line count	ES100

Dimensions in inches (mm)

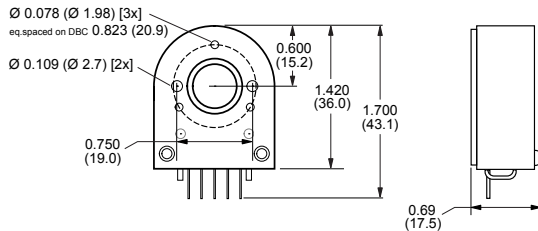

Encoders

Optical encoder	ES* (single-end)	ED* (differential)
Number of signals	3	5
Line counts (1)	100, 200, 250, 400, 500 or 1000	100, 200, 250, 400, 500 or 1000
Mating cable part #	ES-CABLE-2	ED-CABLE-6
Mating cable lengths feet (m)	1.0 (0.3)	6.0 (1.8)

(1) All encoders have an index mark, except the 1000 line count version.

Speed-torque curves

M-3424-6.3•

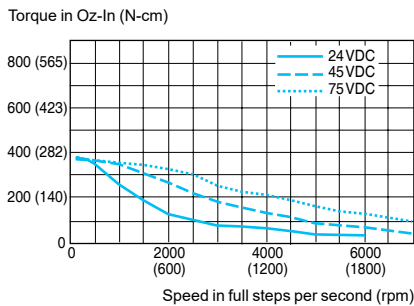



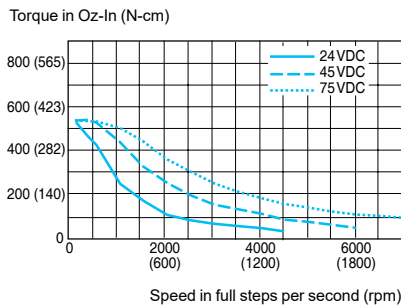

M-3431-6.3•

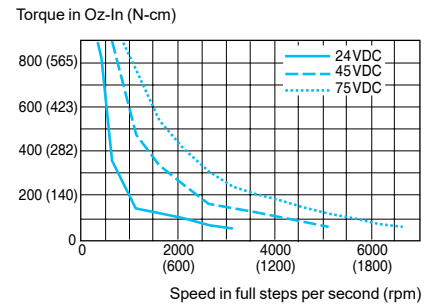

M-3447-6.3•



Complete product offer		M-11•	M-14•	M-17•	M-22•	M-34•
2-phase stepper motors						
Size	NEMA	11	14	17	23	34
Holding torque	oz-in	13 ... 24	10	32 ... 75	90 ... 239	408 ... 1090
	N-cm	9 ... 17	7	23 ... 53	64 ... 169	288 ... 770
Number of full steps per revolution		200				
Step angle α		1.8				
Motor connection		pluggable connector		4 flying leads		

Motor types

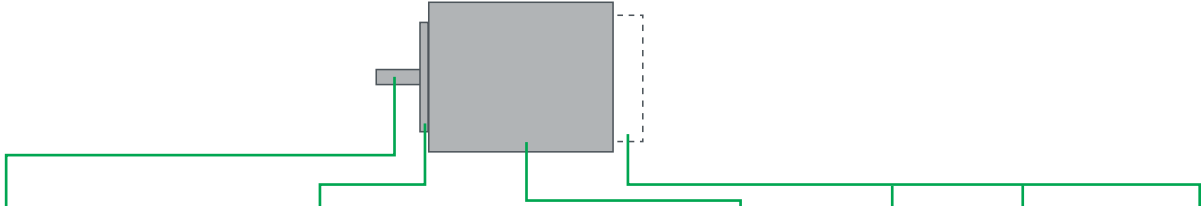

Shaft version	Centering collar		Flange size		Lengths without shaft		Winding	Motor connection	Optional rear shaft (1)	Optional encoder		
	inches	mm	inches	mm	inches	mm						
M-11• Round shaft with single flat feature	Ø 0.197	Ø 5.0	Ø 0.866	Ø 22	0.65	16.5	1.22 1.57 2.01	31 40 51	2-phase full coil for bi-polar operation	pluggable connector	Round shaft	1000-line differential
M-14• Round shaft with single flat feature	Ø 0.197	Ø 5.0	Ø 0.866	Ø 22	1.39	35.3	1.02	26	2-phase full coil for bi-polar operation	4 flying leads	Round shaft	Single-end or differential
M-17• Round shaft with single flat feature	Ø 0.197	Ø 5.0	Ø 0.866	Ø 22	1.67	42.3	1.34 1.57 1.89	34 40 48	2-phase full coil for bi-polar operation	4 flying leads	Flat feature extending to rear end bell	Single-end or differential
M-22• Round shaft with single flat feature	Ø 0.25	Ø 6.35	Ø 1.50	Ø 38	2.22	56.4	1.77 2.13 2.99	45 54 76	2-phase full coil for bi-polar operation	4 flying leads	Flat feature extending to rear end bell (2)	Single-end or differential
M-34• Round shaft with single flat feature	Ø 0.554	Ø 14.0	Ø 2.874	Ø 73	3.386	86.0	2.48 3.15 4.72	63 80 120	2-phase full coil for bi-polar operation	4 flying leads	Flat feature on round shaft	Single-end or differential

(1) Optional rear shaft available except for NEMA23 2.4amp motors.
 (2) Optional rear shaft on NEMA23 6.0amp motors is round without a flat feature.

Schneider Electric Motion USA
 370 North Main Street
 Marlborough, CT 06447 – U.S.A.

motion.schneider-electric.com

© Schneider Electric Motion USA All Rights Reserved. REV121919
 Product Disclaimer and most recent product information online.

Schneider Electric Motion

